

USER MANUAL



Thank you for choosing Better Bathrooms.
Please read this manual before installing your product
and keep for future reference.

better 
bathrooms

Lyra 4mm Pivot Door

BeBa_28004/BeBa_28005

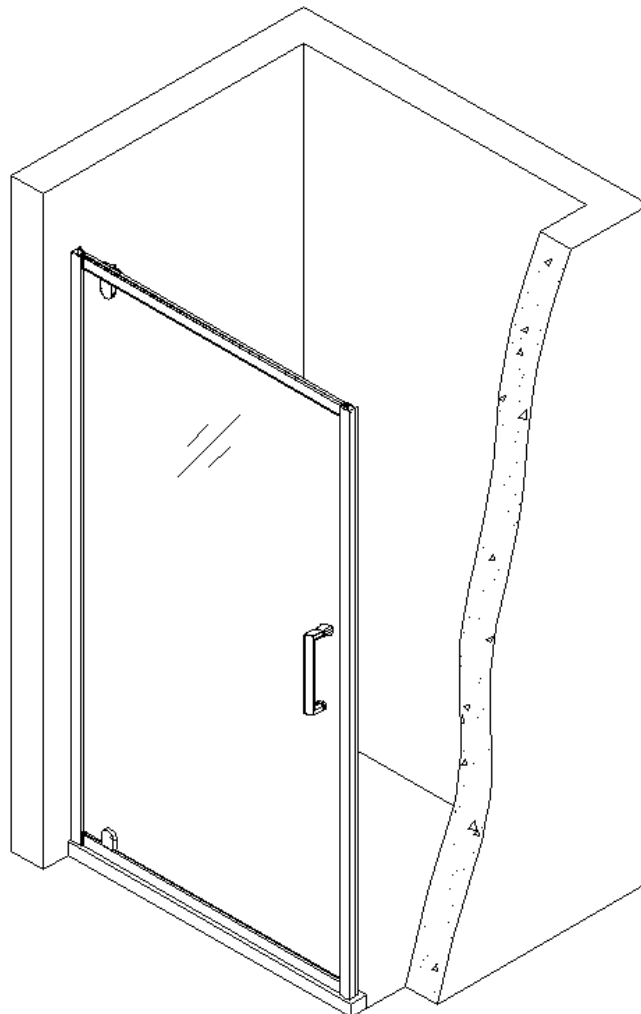

- **Multi-person assembly**
- **Tools required**
- **We always recommend using professional tradespeople to install your product**

2021.8.23

Congratulations on your purchase

And welcome to our growing gang of savvy shoppers

We're on a mission to bring you extraordinary bathroom products, for less. From modern to traditional style ceramics, plus the gorgeous fixtures, fittings and furniture to match. So, you can fall in love with your space every single day.

As one of the UK's largest independent bathroom stores, we've received countless awards; including the National Business Awards UK, the Digital Entrepreneur Awards and being placed on The Sunday Times Fast Track 100.

We hope your new product goes above and beyond your expectations. However, should any problems occur, please:





- log in to your account and contact our customer services team via your self-serve portal –betterbathrooms.com/Account/Login
- contact us via betterbathrooms.com/contact-us

Important information

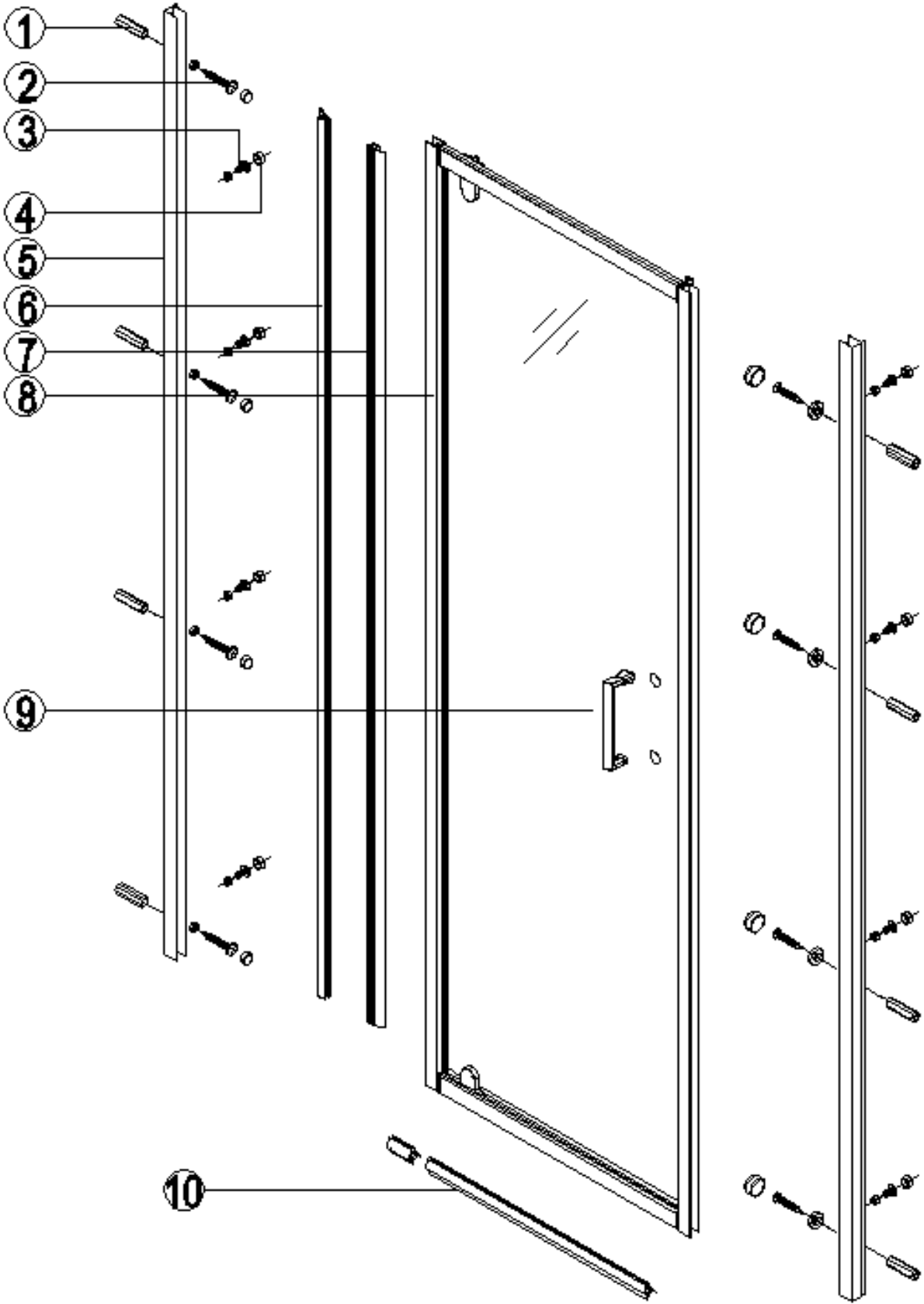
- Please read these instructions thoroughly and retain for future reference
- Manufactured to BS EN 14428
- Please check for pipes and cables before drilling
- Please check for damage prior to installation

Parts / Diagrams

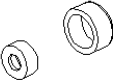
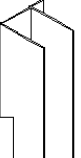
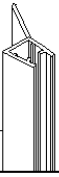

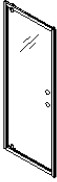
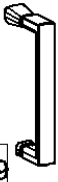
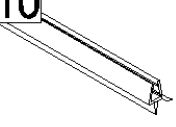
1 	2 	3 	4 	5 
D6x30 8Pcs	ST4X30 8Pcs	ST4X12 8Pcs	RA-09Y07 16Pcs	RA-09W02 2Pcs
6  1755mm	7  1778mm	8  1Pc	9  1Pc	10  1Pcs
RA-09Z14 1Pcs	RA-09Z07 1Pcs		RA-09X09 1Pc	RA-09Z13 1Pcs

Tools required (Tools not provided)

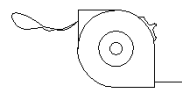
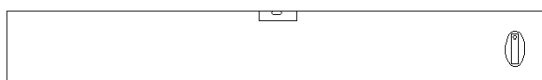
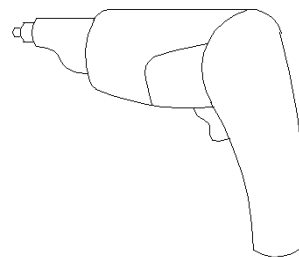
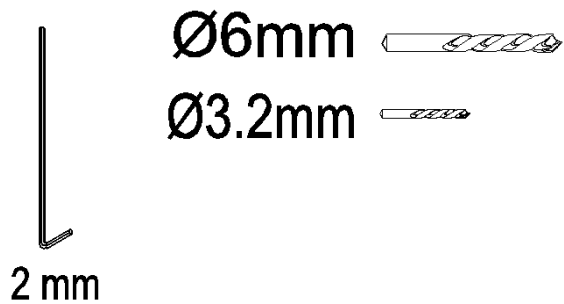
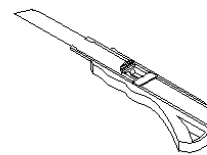
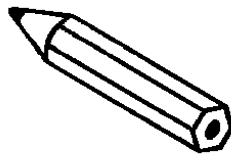
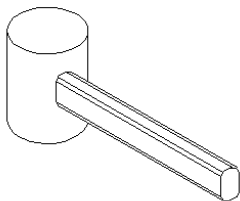
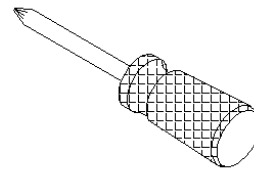
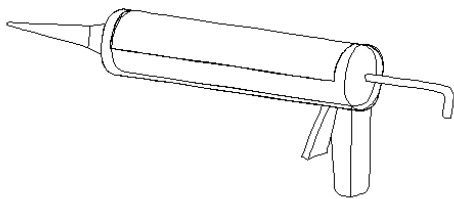

Installation

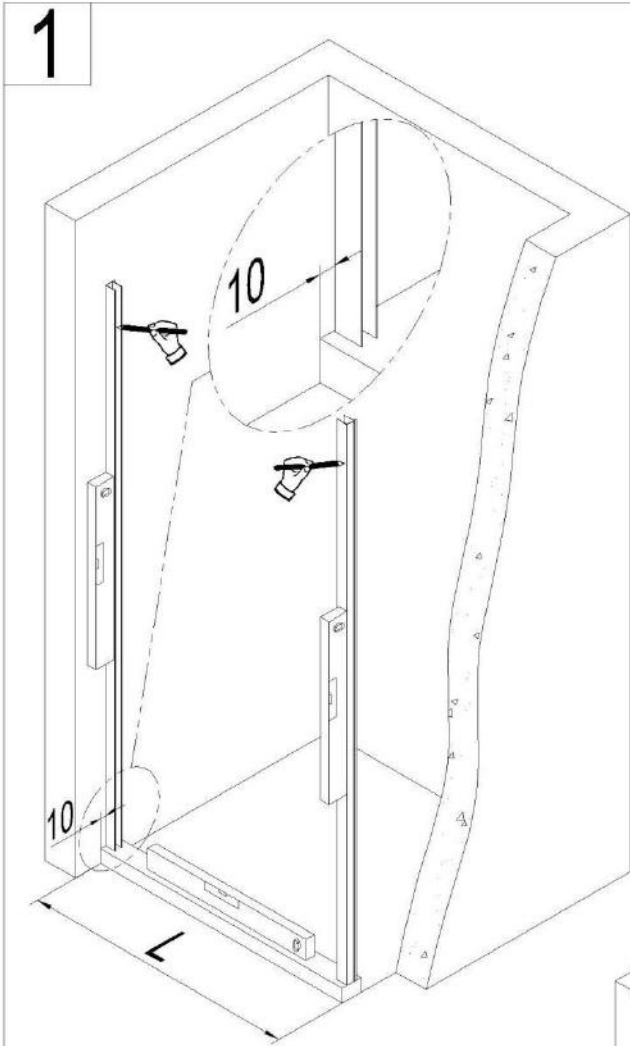

	L
800	750-790
900	850-890

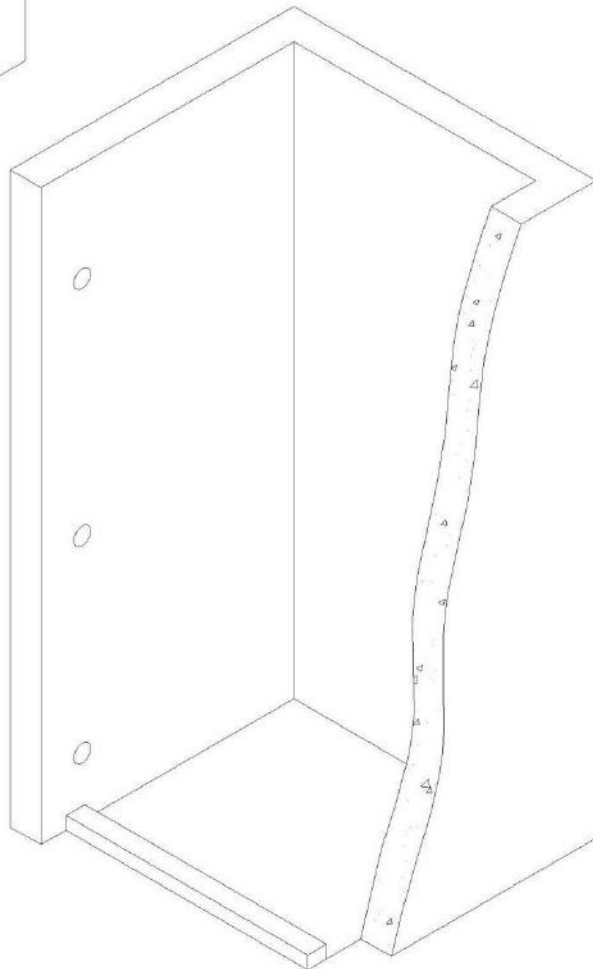
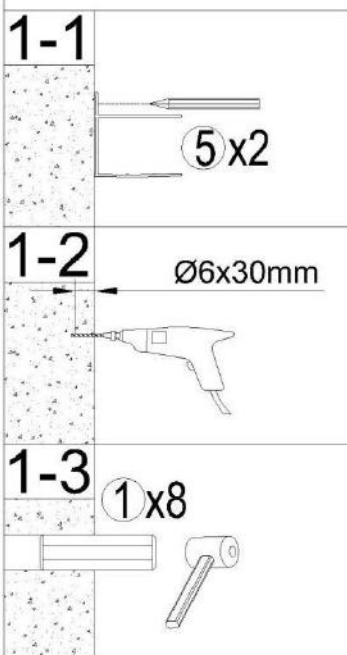

2

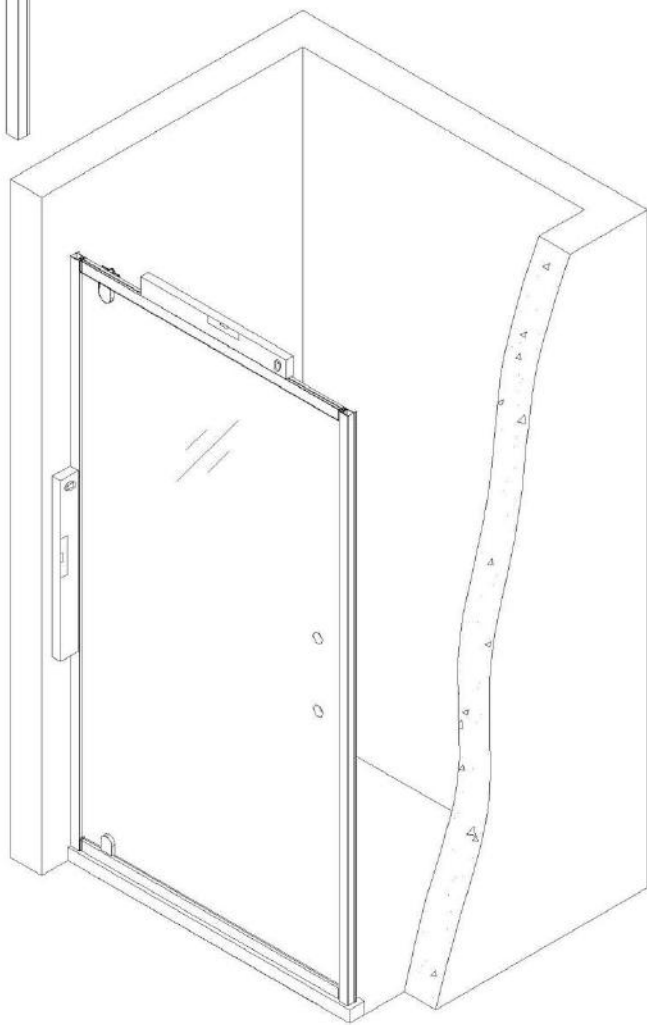
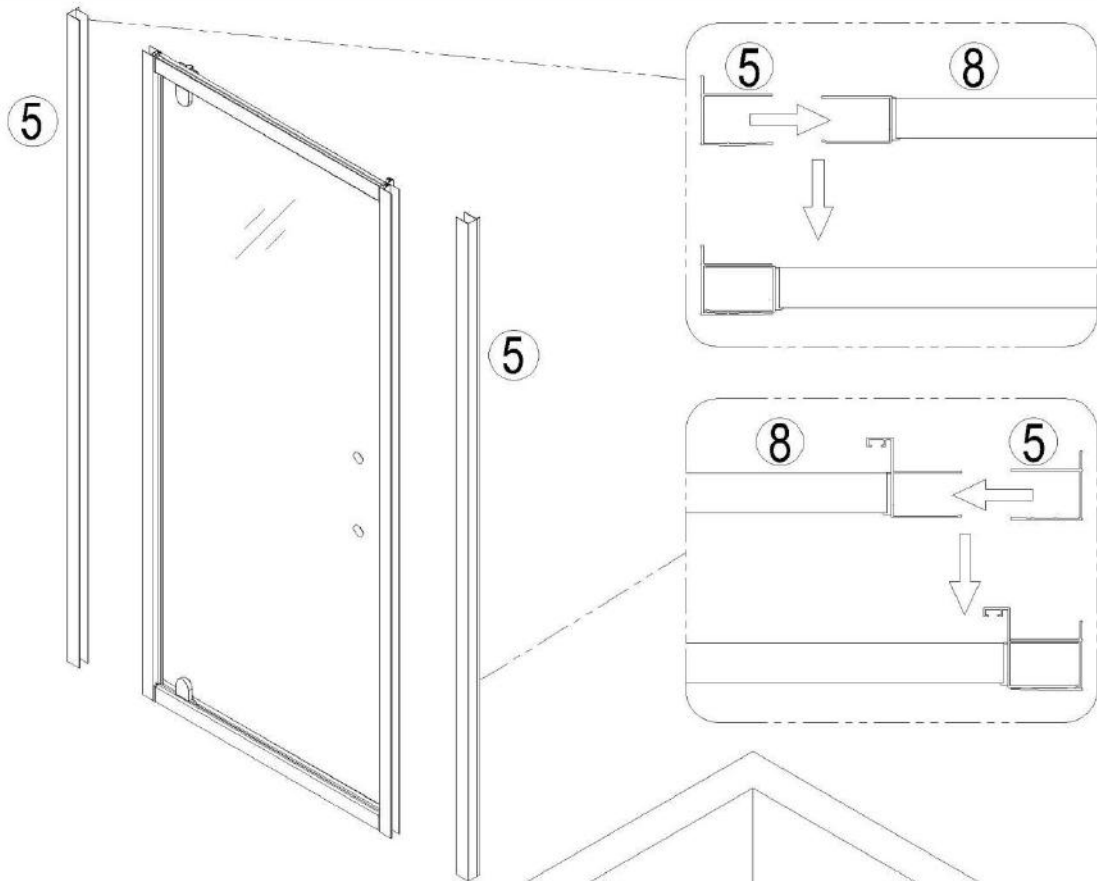

2-1

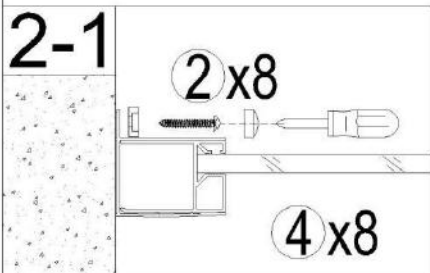

3

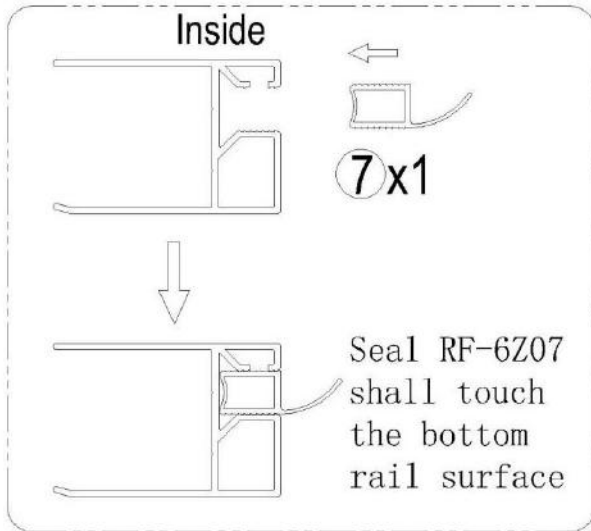

IT IS VERY IMPORTANT TO HAVE THE TOP OF THE GLASS PARALLEL TO THE RAIL BOTTOM FACE, IT MUST HAVE A 10MM EVEN GAP ALL THE WAY ALONG.

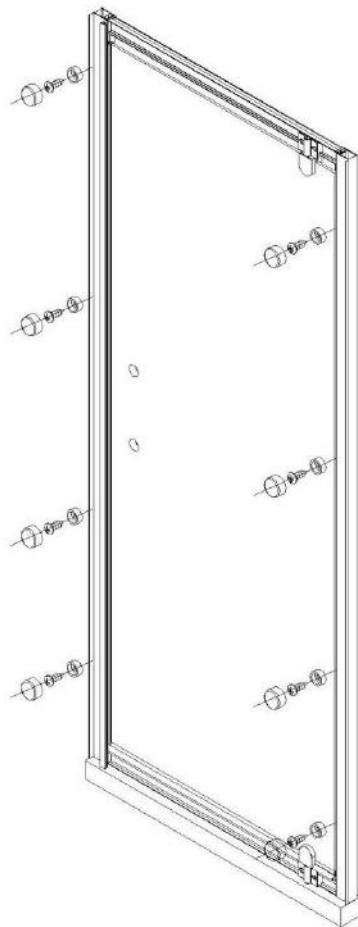
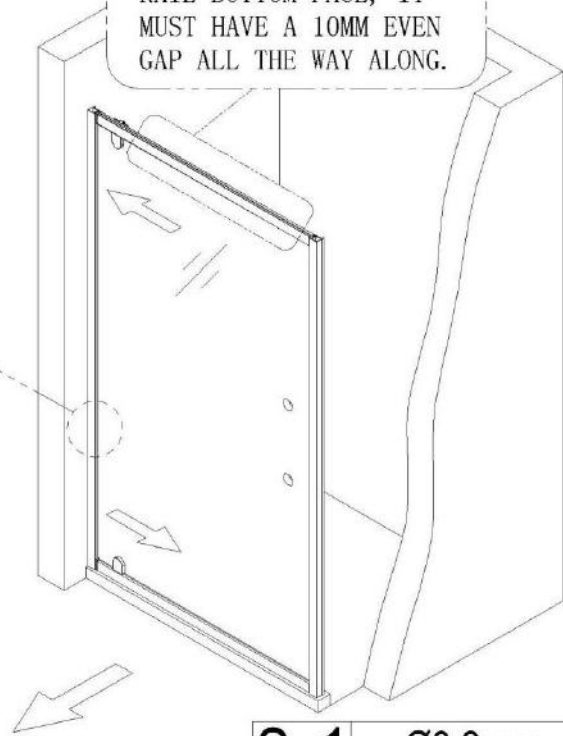

3-1 $\text{Ø}3.2\text{mm}$
0-20mm

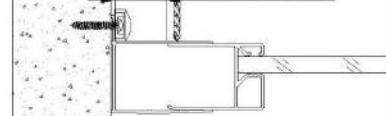

3-2 3x8

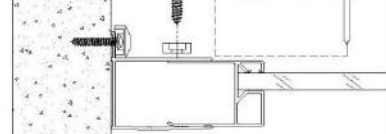

3-3 4x8

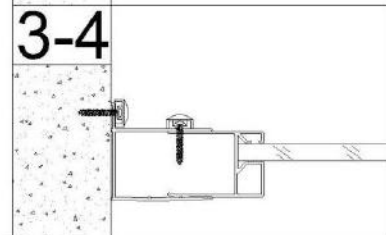
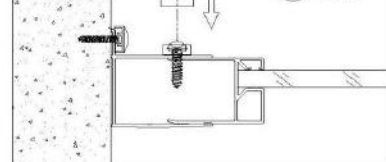

4

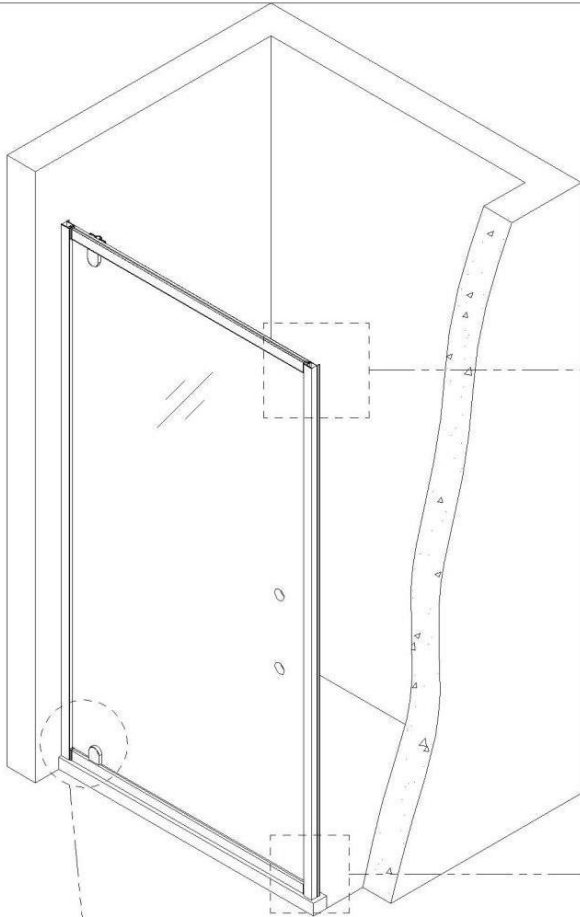

IT IS VERY IMPORTANT TO KEEP THE TOP OF THE MAGNETIC SEAL TO THE SAME HEIGHT OF THE TOP OF THE GLASS.

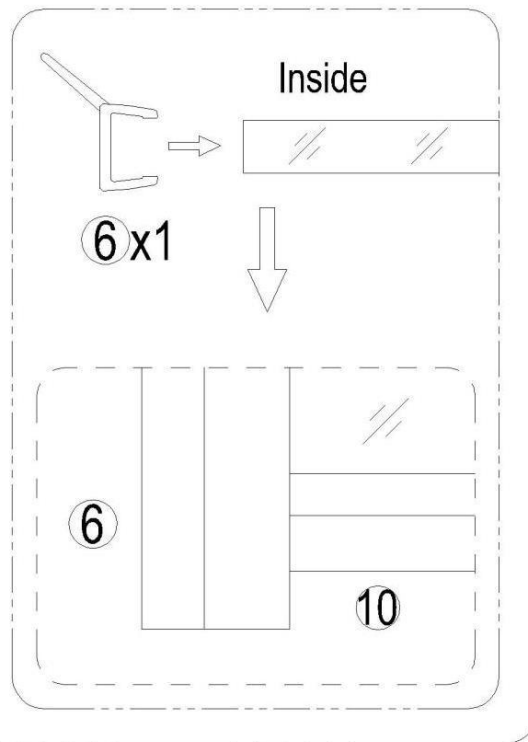
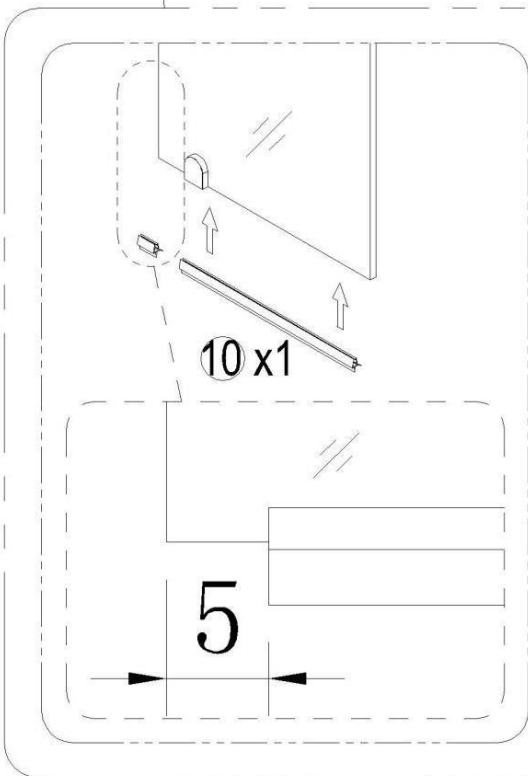
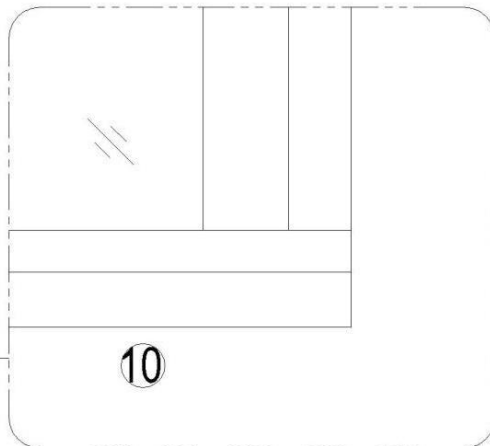
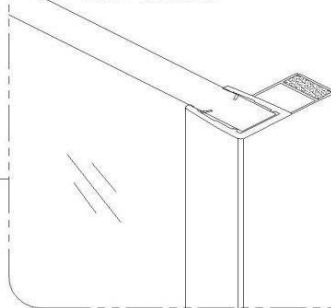

5

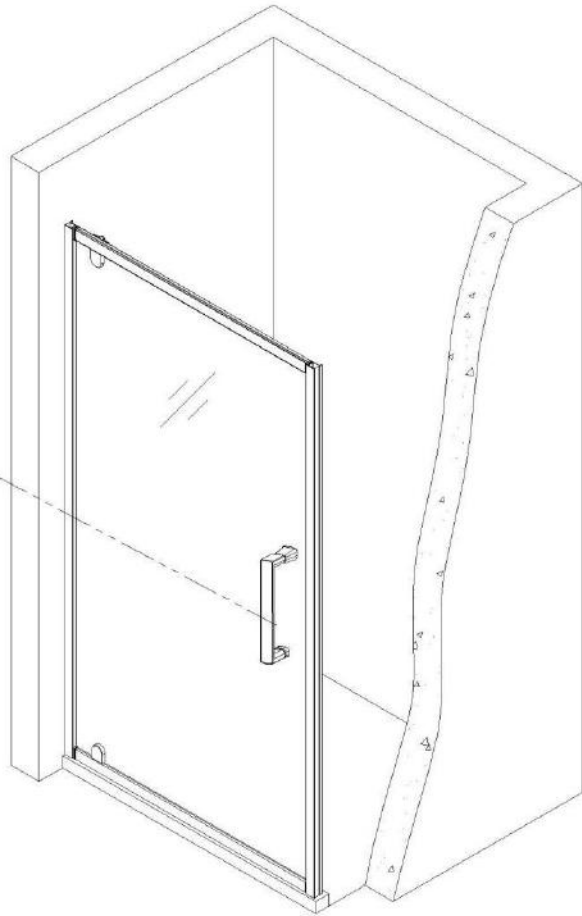
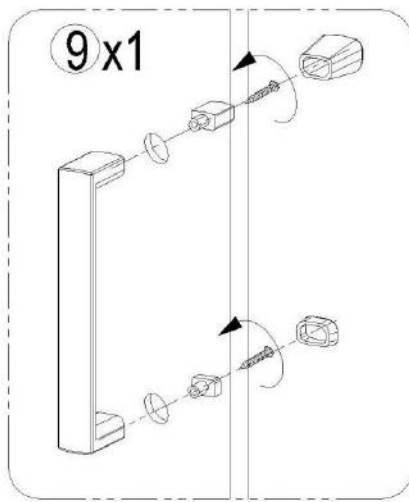

6

Care Instructions:

Do not use your shower enclosure within 24 hours of assembly .

Do not use caustic cleaning products or abrasive material when cleaning your shower enclosure.

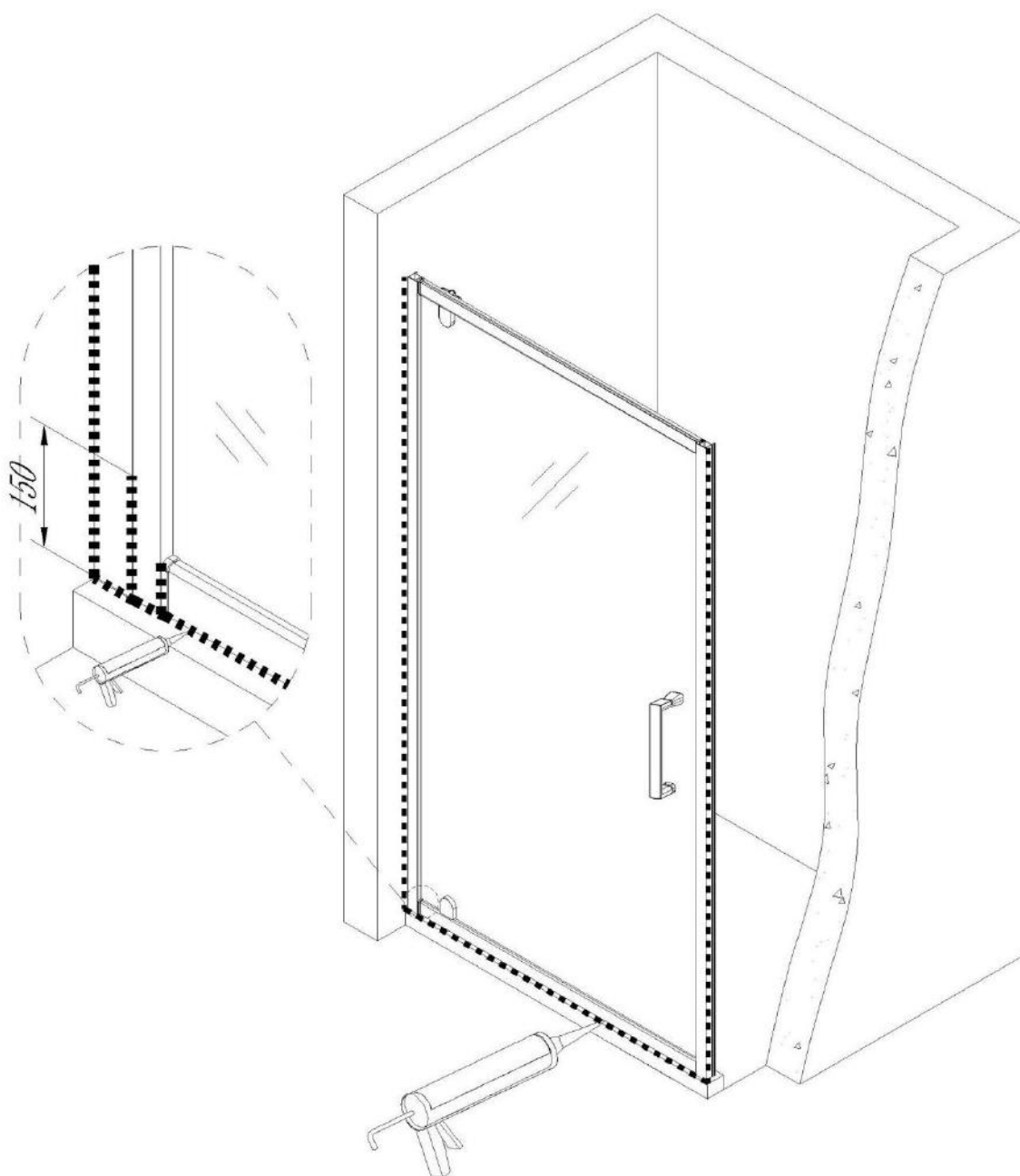

Cleaning

All parts of the product shall be cleaned with a cloth soaked in neutral detergent soapy water, Please do not use sharp tools such as blades to clean the shower door.

Please do not use strong detergent, alcohol or any abrasive cleaning substances to clean the shower door if the stain is serious, a low concentration of vinegar can be used, but must be rinsed with clean water afterwards.

For more information

- visit betterbathrooms.com
- email customerservices@buyitdirect.co.uk
- call 0330 390 3062
- write to Trident Business Park, Neptune Way, Huddersfield, HD2 1UA

better 
bathrooms

Part of the BuyItDirect Group